



# HORIZONTAL AND ADAPTABLE BASE

ES Base Deslizamiento DE Führungsplatte für Waagerechte und Schräge Fläche  
IT Base di Soccorimento PT Base de Deslize FR Embase de Mouvement

● Cad Insertion Point

# BD

Max. 150°C

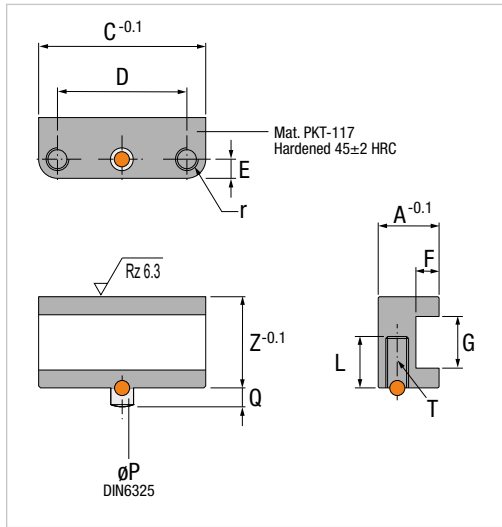

## Horizontal Undercuts

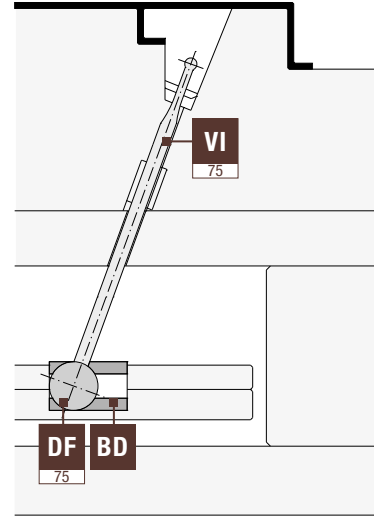

Ref.	A	C	D	E	F	G	L	P	Q	R	T	Z
BD.122036	12	36	28	4	4.8	11.5	10	5	5	4	M5	20
BD.142266	14	66	42	4	6.3	11.5	10	5	5	4	M5	22
BD.162440	16	40	30	5	6.3	13.5	12	6	5	5	M6	24
BD.203260	20	60	44	5	8.3	19	15	6	5	5	M6	32
BD.253872	25	72	56	7	10.3	21	18	8	5	6	M8	38
BD.314890	31	90	74	8	13.3	28	18	10	9	8	M10	48

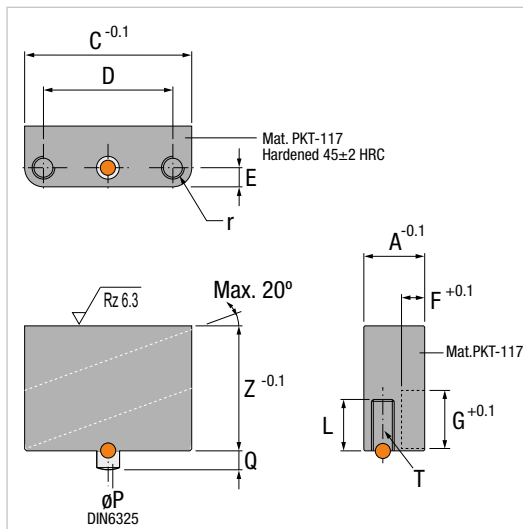

## Angled Undercuts

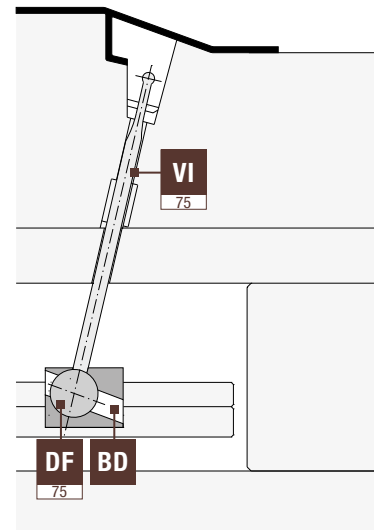

Ref.	A	C	D	E	F	G	L	P	Q	R	T	Z
BD.122836	12	36	28	4	4.8	11.5	10	5	5	4	M5	28
BD.143866	14	66	42	4	6.3	11.5	10	5	5	4	M5	38
BD.163240	16	40	30	5	6.3	13.5	12	6	5	5	M6	32
BD.204060	20	60	44	5	8.3	19	15	6	5	5	M6	40
BD.254672	25	72	56	7	10.3	21	18	8	5	6	M8	46
BD.315890	31	90	74	8	13.3	28	18	10	9	8	M10	58

